



Slatwall | Slatwall

Indoor - Innenbereich





- *  Silver anodised aluminium profiles in E6/EV1.
- * 8 mm thick melamine-faced hardboard body.
- * 30 mm thick hardboard base in 920x410 mm size.
- * Suitable for double sided use.
- * Multifunctional shopfitting.
- * Seven grooves for add-on pockets.
- * Many accessories (e.g., brochure holders, merchandise shelves, hooks, poster frames, poster holders, etc.) can be added to the grooves.
- * Different size options.

- *  Silber eloxierte Aluminiumprofile in E6/EV1.
- * 8 mm Körper aus melaminharzbeschichteter Hartfaserplatte.
- * Fuss aus 30 mm Hartfaserplatte im Format 920x410 mm.
- * Für doppelseitigen Einsatz geeignet.
- * Multifunktionaler Ladenbau.
- * Sieben Nuten für Zusatztaschen.
- * In die Nuten können viele Zubehörteile (z. B. Prospekthalter, Warenregale, Haken, Plakaträhmen, Plakathalter usw.) eingesetzt werden.
- * Verschiedene Größenoptionen.

BROCHURE HOLDERS	MATERIAL: CLEAR ACRYLIC	
	ITEM CODE	SHELF SIZES
	BHSW 1121	120 x 220 mm
	BHSW 1521	150 x 220 mm
	BHSW 2130	220 x 310 mm

POSTER HOLDER	MATERIAL: CLEAR ACRYLIC	
	ITEM CODE	SHELF SIZES
	PSW 030042	300 x 420 mm
	PSW 050070	500 x 700 mm
	PSW 060084	594 x 941 mm

MERCHANDISE SHELF	MATERIAL: CLEAR ACRYLIC	
	ITEM CODE	SHELF SIZES
	RSW 100	150 x 200 mm
	RSW 150	200 x 300 mm
	RSW 200	300 x 300 mm

STEEL HOOK	MATERIAL: GALVANISED STEEL	
	ITEM CODE	HOOK SIZES
	ASW 100	100 mm
	ASW 150	150 mm
	ASW 200	200 mm

Special designs & sizes applicable upon your request.

EXTRUSION: SILVER COLOR (ANODIZED) ALUMINIUM

and melamine faced hardboard panels

ITEM CODE	GROOVES	EXTERNAL SIZE
DSS 08221500 -7	7	920 x 410 x 1550 mm
DSS 08221800 -7	7	920 x 410 x 1850 mm

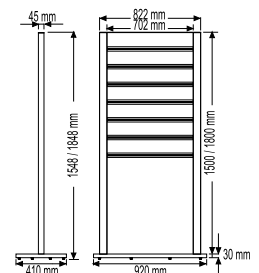

Slatwall Totem | Slatwall Totem

Indoor - Innenbereich



-  * Silver anodised aluminium profiles in E6/EV1.
- * MDF body and PVC laminated baseplate in 410x430 mm.
- * Suitable for double sided use.
- * Multifunctional shopfitting.
- * 1838x410 mm total size.
- * Eight grooves for add-on pockets.
- * Many accessories (e.g., brochure holders, merchandise shelves, hooks, poster frames, poster holders, etc.) can be added to the grooves.

-  * Silber eloxierte Aluminiumprofile in E6/EV1.
- * MDF-Körper und PVC-laminierte Bodenplatte in 410x430 mm.
- * Für doppelseitigen Einsatz geeignet.
- * Multifunktionaler Ladenbau.
- * 1838x410 mm Gesamtgröße.
- * Acht Nuten für Zusatztaschen.
- * In die Nuten können viele Zubehörteile (z. B. Prospekthalter, Warenregale, Haken, Plakaträhmen, Plakathalter usw.) eingesetzt werden.



STEEL HOOK

MATERIAL: GALVANISED STEEL

ITEM CODE	HOOK SIZES
ASW 100	100 mm
ASW 150	150 mm
ASW 200	200 mm

Special designs & sizes applicable upon your request.

EXTRUSION: SILVER COLOR (ANODIZED) ALUMINIUM

and melamine faced hardboard panels

ITEM CODE	GROOVES	EXTERNAL SIZE
TSW 0321800-4	8	1838 x 410 mm

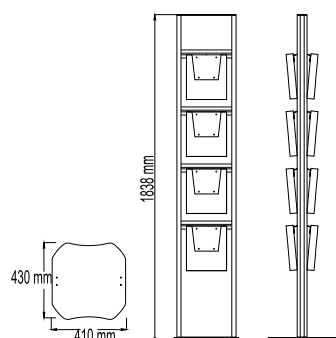

BROCHURE HOLDERS

MATERIAL: CLEAR ACRYLIC

ITEM CODE	SHELF SIZES
BHSW 1121	120 x 220 mm
BHSW 1521	150 x 220 mm
BHSW 2130	220 x 310 mm



POSTER HOLDER

MATERIAL: CLEAR ACRYLIC

ITEM CODE	SHELF SIZES
PSW 030042	300 x 420 mm
PSW 050070	500 x 700 mm
PSW 060084	594 x 941 mm



MERCHANDISE SHELF

MATERIAL: CLEAR ACRYLIC

ITEM CODE	SHELF SIZES
RSW 100	150 x 200 mm
RSW 150	200 x 300 mm
RSW 200	300 x 300 mm



Slatwall Stand | Lemellenwand Ständer

Indoor - Innenbereich

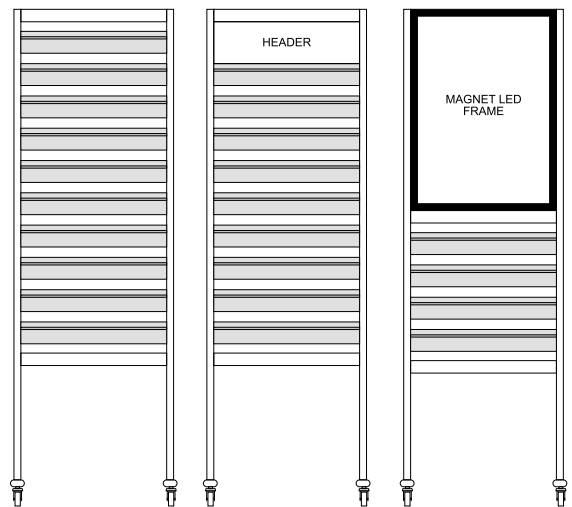

-  * Silver anodised aluminium profiles in E6/EV1.
- * 8 mm thick melamine-faced hardboard body.
- * T-foot design and easy transportation with wheels.
- * 1700 mm total height.
- * Suitable for double sided use.
- * Multifunctional shopfitting.
- * Grooves for add-on pockets.
- * Many accessories (e.g., brochure holders, magnetic frames, merchandise shelves, hooks, header, snap frames, poster holders, etc.) can be added to the grooves.

-  * Silber eloxierte Aluminiumprofile in E6/EV1.
- * 8 mm melaminharzbeschichtete Hartfaserplatte.
- * T-Fuß-Design und einfacher Transport mit Rädern.
- * 1700 mm Gesamthöhe.
- * Für doppelseitigen Einsatz geeignet.
- * Multifunktionaler Ladenbau.
- * Rillen für Zusatztaschen.
- * In die Nuten können viele Zubehörteile (z. B. Prospekthalter, Magnetrahmen, Warenregale, Haken, Header, Klapprahmen, Plakathalter usw.) eingesetzt werden.

BROCHURE
HOLDERS



MATERIAL: CLEAR ACRYLIC

ITEM CODE	SHELF SIZES
BHSW 1121	120 x 220 mm
BHSW 1521	150 x 220 mm
BHSW 2130	220 x 310 mm

POSTER
HOLDER



MATERIAL: CLEAR ACRYLIC

ITEM CODE	SHELF SIZES
PSW 030042	300 x 420 mm
PSW 050070	500 x 700 mm
PSW 060084	594 x 941 mm

MERCHANDISE
SHELF



MATERIAL: CLEAR ACRYLIC

ITEM CODE	SHELF SIZES
RSW 100	150 x 200 mm
RSW 150	200 x 300 mm
RSW 200	300 x 300 mm

STEEL
HOOK

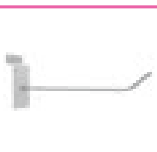

MATERIAL: GALVANISED STEEL

ITEM CODE	HOOK SIZES
ASW 100	100 mm
ASW 150	150 mm
ASW 200	200 mm

Special designs & sizes applicable upon your request.

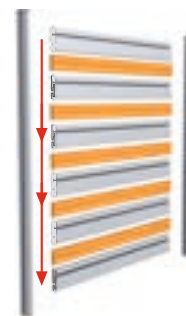

EXTRUSION: SILVER COLOR (ANODIZED) ALUMINIUM

and melamine faced hardboard panels

ITEM CODE	GROOVES	EXTERNAL SIZE
SWD 6021700	10	602 x 1700 mm
SWD 6961700	10	696 x 1700 mm

WITH HEADER

ITEM CODE	GROOVES	EXTERNAL SIZE	HEADER
SWD 6021700 A	9	602 x 1700 mm	602 x 150 mm
SWD 6961700 A	9	696 x 1700 mm	696 x 150 mm

WITH LIGHTBOX

ITEM CODE	GROOVES	EXTERNAL SIZE	LIGHTBOX
SWD 6021700 LED	4	602 x 1700 mm	B2
SWD 6961700 LED	4	696 x 1700 mm	A1

Slatwall Gondola | Lamellenwand Gondel

Indoor - Innenbereich



- * Silver anodised aluminium profiles in E6/EV1.
- * 8 mm thick melamine-faced hardboard body.
- * Shaped steel base for extra stability.
- * Suitable for double sided use.
- * Multifunctional shopfitting.
- * Five grooves for add-on pockets.
- * Many accessories (e.g., sale globes, brochure holders, merchandise shelves, hooks, poster frames, poster holders, etc.) can be added to the grooves.
- * Size options and creating endless configuration opportunity by adding more panels to each other.



- * Silber eloxierte Aluminiumprofile in E6/EV1.
- * 8 mm melaminharzbeschichtete Hartfaserplatte.
- * Geformter Stahlfuss für zusätzliche Stabilität.
- * Für doppelseitigen Einsatz geeignet.
- * Multifunktionaler Ladenbau.
- * Fünf Rillen für Zusatztaschen.
- * In die Nuten können viele Zubehörteile (z. B. Verkaufskugeln, Prospekthalter, Warenregale, Haken, Plakaträhmen, Plakathalter usw.) eingesetzt werden.
- * Größenoptionen und endlose Konfigurationsmöglichkeiten durch Hinzufügen weiterer Paneele.



Header/Wing screws

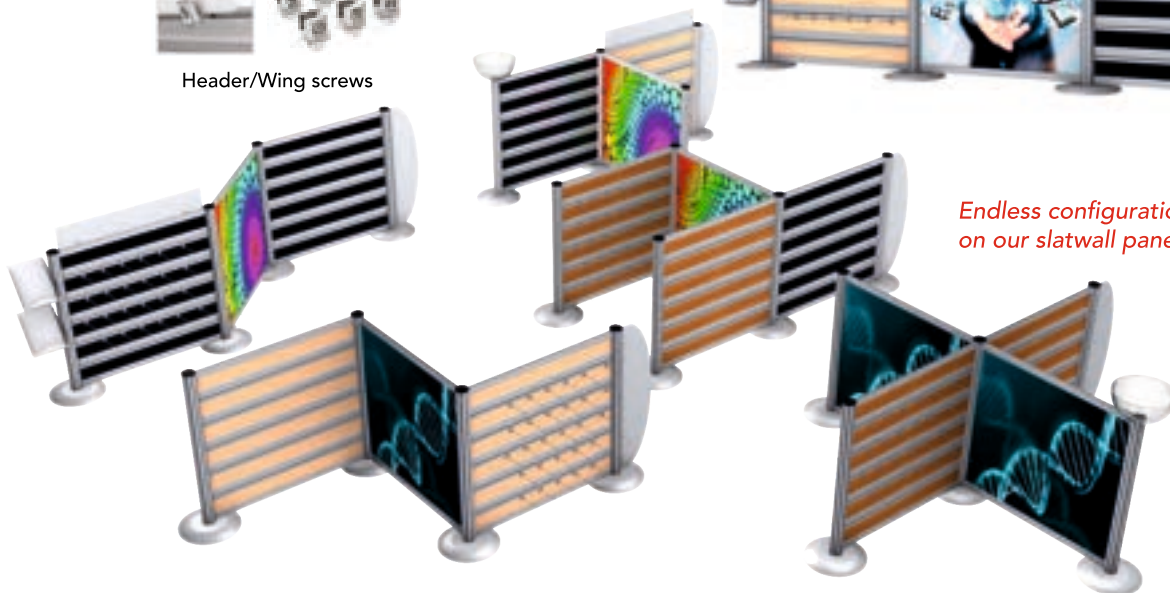

Endless configuration on our slatwall panels

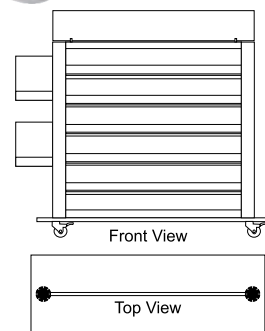
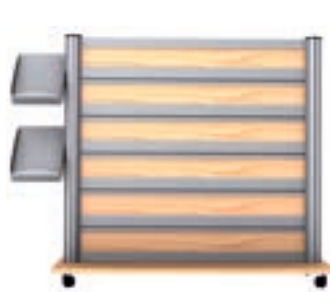
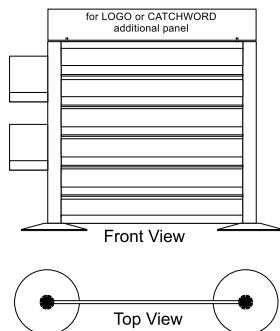

ITEM CODE	ADD. PANELS	GROOVES	EXTERNAL SIZE
SWD 100100		5	1430 x 1040 x 360 mm
SWD ADD 100100	1	5	1210 x 1040 x 360 mm

ITEM CODE	GROOVES	EXTERNAL SIZE
SWDT 100100	5	1200 x 1080 x 400 mm

Tower Showcase | Turm Vitrinen

Indoor - Innenbereich



-  * Silver anodised aluminum body profiles in E6/EV1.
- * 3 pieces 6 mm thick tempered glass adjustable shelves.
- * Chrome-plated glass carriers.
- * 5 mm thick lockable tempered glass door. 2 keys included.
- * MDF top and base.
- * Four wheels for easy transportation (2x with brake)
- * 500x500x2000 mm total dimension.
- * Flat disassembled package available.
- * As requested disassembled, easy assembly within a couple of minutes.

-  * Silber eloxierte Aluminium-Körperprofile in E6/EV1.
- * 4 Stück verstellbare Einlegeböden aus 6 mm starkem gehärtetem Glas.
- * Verchromte Glasträger.
- * 5 mm dicke, abschließbare Tür aus gehärtetem Glas. 2 Schlüssel enthalten.
- * MDF-Oberseite und -Basis.
- * Vier Räder für einfachen Transport (2x mit Bremse)
- * 500x500x2000 mm Gesamtabmessung.
- * Flache zerlegte Verpackung erhältlich.
- * Auf Wunsch zerlegt, einfache Montage innerhalb weniger Minuten.

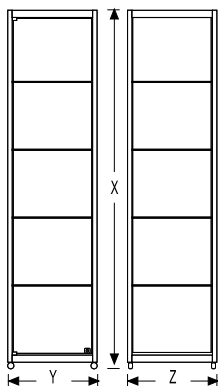

EXTRUSION: ALUMINIUM & TEMPERED GLASS

ITEM CODE	EXTERNAL SIZE (Y*Z*X)
SC 5050200	500 x 500 x 2000 mm

LED Illuminated Tower Showcase

LED Beleuchtete Turm Schaukasten



Tower Showcase "with Storage" | Turm Vitrinen "mit Unterschrank"



Indoor - Innenbereich

- * Silver anodised aluminum body profiles in E6/EV1.
- * 3 pieces 6 mm thick tempered glass adjustable shelves.
- * Chrome-plated glass carriers.
- * 5 mm thick lockable tempered glass door. 2 keys included.
- * MDF top, base and storage.
- * Lockable storage in 500x500x350 mm size. Keys are included.
- * Four wheels for easy transportation (2x with brake)
- * Optional LED lighting applicable on edges.
- * 500x500x2000 mm total dimension.
- * Flat disassembled package available.

- * Silber eloxierte Aluminium-Körperprofile in E6/EV1.
- * 3 Stück verstellbare Einlegeböden aus 6 mm starkem gehärtetem Glas.
- * Verchromte Glasträger.
- * 5 mm dicke, abschließbare Tür aus gehärtetem Glas. 2 Schlüssel enthalten.
- * Platte, Boden und Stauraum aus MDF.
- * Abschließbarer Stauraum im Format 500x500x350 mm. Schlüssel sind enthalten.
- * Vier Räder für einfachen Transport (2x mit Bremse)
- * Optionale LED-Beleuchtung an den Kanten anwendbar.
- * 500x500x2000 mm Gesamtabmessung.
- * Flache zerlegte Verpackung erhältlich.

EXTRUSION: ALUMINIUM & TEMPERED GLASS

ITEM CODE	EXTERNAL SIZE (Y*Z*X)
SCD 5050200	500 x 500 x 2000 mm

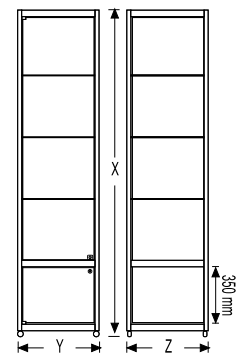

Tower Showcase "Wide" | Turm Vitrinen "Breit"

Indoor - Innenbereich



-  * Silver anodised aluminum body profiles in E6/EV1.
- * Built up to CE specifications.
- * Wider design.
- * 4 pieces 8 mm thick tempered glass adjustable shelves.
- * Chrome-plated glass carriers.
- * 5 mm thick lockable tempered glass door. 2 keys included.
- * MDF top and base.
- * Four wheels for easy transportation (2x with brake)
- * Optional LED lighting applicable on edges.
- * 500x950x2000 mm total dimension.
- * Flat disassembled package available.

-  * Silber eloxierte Aluminium-Körperprofile in E6/EV1.
- * Breiteres Design.
- * 4 verstellbare Einlegeböden aus 8 mm starkem gehärtetem Glas.
- * Verchromte Glasträger.
- * 5 mm dicke, abschließbare Tür aus gehärtetem Glas. 2 Schlüssel enthalten.
- * MDF-Oberseite und -Basis.
- * Vier Räder für einfachen Transport (2x mit Bremse)
- * Optionale LED-Beleuchtung an den Kanten anwendbar.
- * 500x950x2000 mm Gesamtabmessung.
- * Flache zerlegte Verpackung erhältlich.



LED Illuminated Tower Showcase

LED Beleuchtete Turm Schaukasten

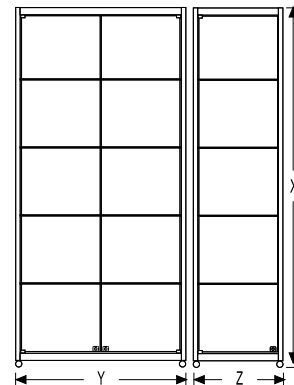

EXTRUSION: ALUMINIUM & TEMPERED GLASS

ITEM CODE	EXTERNAL SIZE (Y*Z*X)
SC 9550200	960 x 500 x 2000 mm



Tower Showcase "Wide-with Storage" | Turm Vitrinen "Breit-mit Unterschrank"



Indoor - Innenbereich

- * Silver anodised aluminum body profiles in E6/EV1.
- * Wider design.
- * 3 pieces 8 mm thick tempered glass adjustable shelves.
- * Chrome-plated glass carriers.
- * 5 mm thick lockable tempered glass door. 2 keys included.
- * MDF top and base.
- * Lockable MDF storage in 950x500x350 mm size. Keys are included.
- * Four wheels for easy transportation (2x with brake)
- * Optional LED lighting applicable on edges.
- * 500x950x2000 mm total dimension.
- * Flat disassembled package optional.

- * Silber eloxierte Aluminium-Körperprofile in E6/EV1.
- * Breiteres Design.
- * 3 Stück verstellbare Einlegeböden aus 8 mm starkem gehärtetem Glas.
- * Verchromte Glasträger.
- * 5 mm dicke, abschließbare Tür aus gehärtetem Glas. 2 Schlüssel enthalten.
- * MDF-Oberseite und -Basis.
- * Abschließbare MDF-Aufbewahrung im Format 950x500x350 mm. Schlüssel sind enthalten.
- * Vier Räder für einfachen Transport (2x mit Bremse)
- * Optionale LED-Beleuchtung an den Kanten anwendbar.
- * 500x950x2000 mm Gesamtabmessung.
- * Flache zerlegte Verpackung optional.

EXTRUSION: ALUMINIUM & TEMPERED GLASS

ITEM CODE	EXTERNAL SIZE (Y*Z*X)
SCD 9550200	960 x 500 x 2000 mm

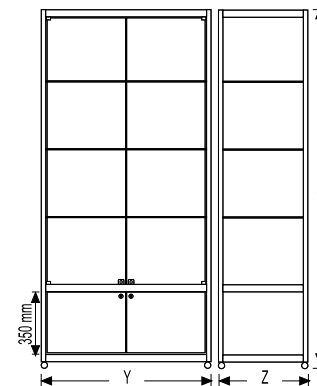

Tower Showcase "Sliding Doors" | Turm Vitrinen "Schiebetüren"

Indoor - Innenbereich



-  * Silver anodised aluminum body profiles in E6/EV1.
- * 4 pieces 8 mm thick tempered glass adjustable shelves.
- * Chrome-plated glass carriers.
- * 5 mm thick sliding lockable tempered glass door. 2 keys included.
- * MDF top and base.
- * Four wheels for easy transportation (2x with brake)
- * Optional LED lighting applicable on edges.
- * 950x500x2000 mm total dimension.
- * Flat disassembled package available.

-  * Silber eloxierte Aluminium-Körperprofile in E6/EV1.
- * Gebaut nach CE-Spezifikationen.
- * 4 verstellbare Einlegeböden aus 8 mm starkem gehärtetem Glas.
- * Verchromte Glasträger.
- * 5 mm dicke, abschließbare Schiebetür aus gehärtetem Glas. 2 Schlüssel enthalten.
- * MDF-Oberseite und -Basis.
- * Vier Räder für einfachen Transport (2x mit Bremse)
- * Optionale LED-Beleuchtung an den Kanten anwendbar.
- * 950x500x2000 mm Gesamtabmessung.
- * Flache zerlegte Verpackung erhältlich.

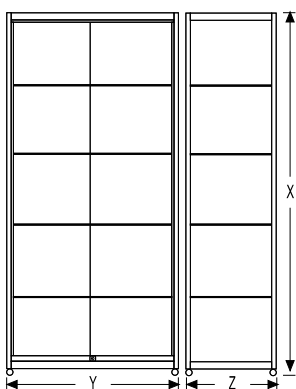

EXTRUSION: ALUMINIUM & TEMPERED GLASS

ITEM CODE	EXTERNAL SIZE (Y*Z*X)
SCS 9550200	960 x 500 x 2000 mm



Tower Showcase "Sliding Doors with Storage" | Turm Vitrinen "Schiebetüren mit Unterschrank"



Indoor - Innenbereich



- * Silver anodised aluminum body profiles in E6/EV1.
- * Built up to CE specifications.
- * 3 pieces 8 mm thick tempered glass adjustable shelves.
- * Chrome-plated glass carriers.
- * 5 mm thick lockable sliding tempered glass door. 2 keys included.
- * MDF top and base.
- * Lockable MDF storage in 950x500x350 mm size. Keys are included.
- * Four wheels for easy transportation (2x with brake)
- * Optional LED lighting applicable on edges.
- * 500x950x2000 mm total dimension.
- * Flat disassembled package available.



- * Silber eloxierte Aluminium-Körperprofile in E6/EV1.
- * Gebaut nach CE-Spezifikationen.
- * 3 Stück verstellbare Einlegeböden aus 8 mm starkem gehärtetem Glas.
- * Verchromte Glasträger.
- * 5 mm dicke, abschließbare Schiebetür aus gehärtetem Glas. 2 Schlüssel enthalten.
- * MDF-Oberseite und -Basis.
- * Abschließbare MDF-Aufbewahrung im Format 950x500x350 mm. Schlüssel sind enthalten.
- * Vier Räder für einfachen Transport (2x mit Bremse)
- * Optionale LED-Beleuchtung an den Kanten anwendbar.
- * 500x950x2000 mm Gesamtabmessung.
- * Flache zerlegte Verpackung erhältlich.

EXTRUSION: ALUMINIUM & TEMPERED GLASS

ITEM CODE	EXTERNAL SIZE (Y*Z*X)
SCSD 9550200	960 x 500 x 2000 mm

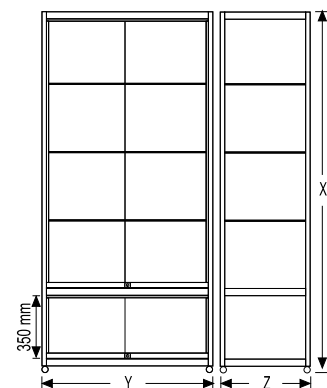

Retail & Counter Showcase | *Thekenvitrine*

Indoor - Innenbereich



-  * Silver anodised aluminum body profiles in E6/EV1.
- * Built up to CE specifications.
- * 2 pieces 6 mm thick tempered glass shelves.
- * Chrome-plated glass carriers.
- * 5 mm thick sliding and lockable tempered glass two doors. 2 keys included.
- * 8 mm thick MDF base.
- * Four wheels for easy transportation (2x with brake)
- * Optional LED illumination.
- * 1000x500x1000 mm total dimension.
- * Flat disassembled package available.

-  * Silber eloxierte Aluminium-Körperprofile in E6/EV1.
- * Gebaut nach CE-Spezifikationen.
- * 2 Stück 6 mm dicke Böden aus gehärtetem Glas.
- * Verchromte Glasträger.
- * 5 mm dicke Schiebe- und abschließbare Türen aus gehärtetem Glas. 2 Schlüssel enthalten.
- * 8 mm starke MDF-Basis.
- * Vier Räder für einfachen Transport (2x mit Bremse)
- * Optionale LED-Beleuchtung.
- * 1000x500x1000 mm Gesamtmaßung.
- * Flache zerlegte Verpackung erhältlich.

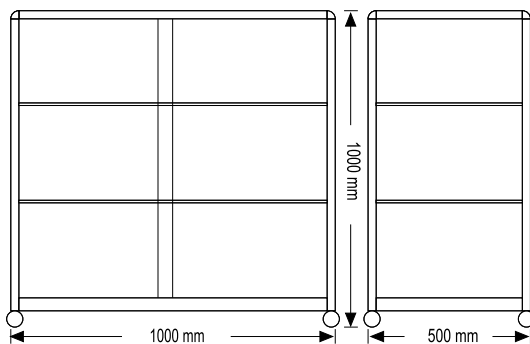

EXTRUSION: ALUMINIUM & TEMPERED GLASS

FULL-VISION CONSTRUCTION

ITEM CODE	EXTERNAL SIZE (Y*Z*X)
SCR 10050100	1000 x 500 x 1000 mm

WITH LOCKING STORAGE

ITEM CODE	EXTERNAL SIZE (Y*Z*X)
SCRD 10050100	1000 x 500 x 1000 mm



Wall Vitrine | Wandvitrine



Indoor - Innenbereich



- * Silver anodised aluminum body profiles in E6/EV1.
- * Built up to CE specifications.
- * Wall-mounted design. Mounting equipment included.
- * Two pieces 8 mm thick tempered glass shelves.
- * Chrome-plated glass carriers.
- * 5 mm thick sliding lockable tempered glass two doors. 2 keys included.
- * Chrome, rounded corners for safety.
- * Solid white MDF side, top, bottom and back panels.
- * Optional LED lighting applicable on edges.
- * 1000x1000x200 mm total dimension.



- * Silber eloxierte Aluminium-Körperprofile in E6/EV1.
- * Gebaut nach CE-Spezifikationen.
- * Wandmontiertes Design. Inklusive Montagematerial.
- * Zwei Stück 8 mm dicke Einlegeböden aus gehärtetem Glas.
- * Verchromte Glasträger.
- * 5 mm dicke verschiebbare, abschließbare Türen aus gehärtetem Glas. 2 Schlüssel enthalten.
- * Chrom, abgerundete Ecken zur Sicherheit.
- * Seiten-, Ober-, Unter- und Rückwände aus massivem weißem MDF.
- * Optionale LED-Beleuchtung an den Kanten anwendbar.
- * 1000x1000x200 mm Gesamtabmessung.

EXTRUSION: ALUMINIUM & TEMPERED GLASS

ITEM CODE	EXTERNAL SIZE (Y*Z*X)
SCSW 10020100	1000 x 200 x 1000 mm

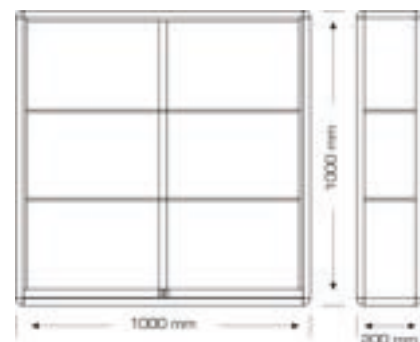

Frameless Glass Tower Showcase | Rahmenlos Glasturm vitrine

Indoor - Innenbereich



- *  Extra-toughened safety tempered glass.
- * Full unobstructed view with frameless structure.
- * Built up to CE specifications.
- * 3 pieces, fixed 6 mm tempered glass shelves.
- * 380 mm distance between two layers.
- * Chrome-plated glass carriers.
- * 5 mm thick lockable and hinged tempered glass door. 2 keys included.
- * 18 mm thick black, wooden base and top.
- * 400x400x1600 mm total dimension.
- * Flat disassembled package.

- *  Extra gehärtetes Sicherheitsglas.
- * Volle ungehinderte Sicht mit rahmenloser Struktur.
- * Gebaut nach CE-Spezifikationen.
- * 3 Stück, feste 6 mm Einlegeböden aus gehärtetem Glas.
- * 380 mm Abstand zwischen zwei Lagen.
- * Verchromte Glasträger.
- * 5 mm dicke, abschließbare und aufklappbare Tür aus gehärtetem Glas. 2 Schlüssel enthalten.
- * 18 mm dick, schwarz, Sockel und Platte aus Holz.
- * 400x400x1600 mm Gesamtabmessung.
- * Flache zerlegte Verpackung.

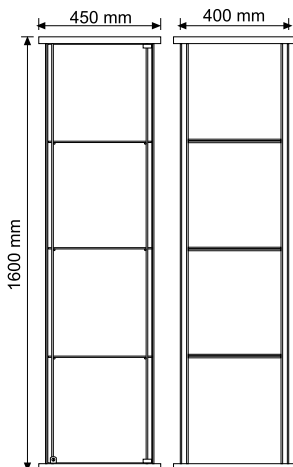

EXTRUSION: TEMPERED GLASS & MDF

ITEM CODE	EXTERNAL SIZE (Y*Z*X)
SCT 4016040	400 x 1600 x 400 mm

